



**Electra Steam, Inc.**

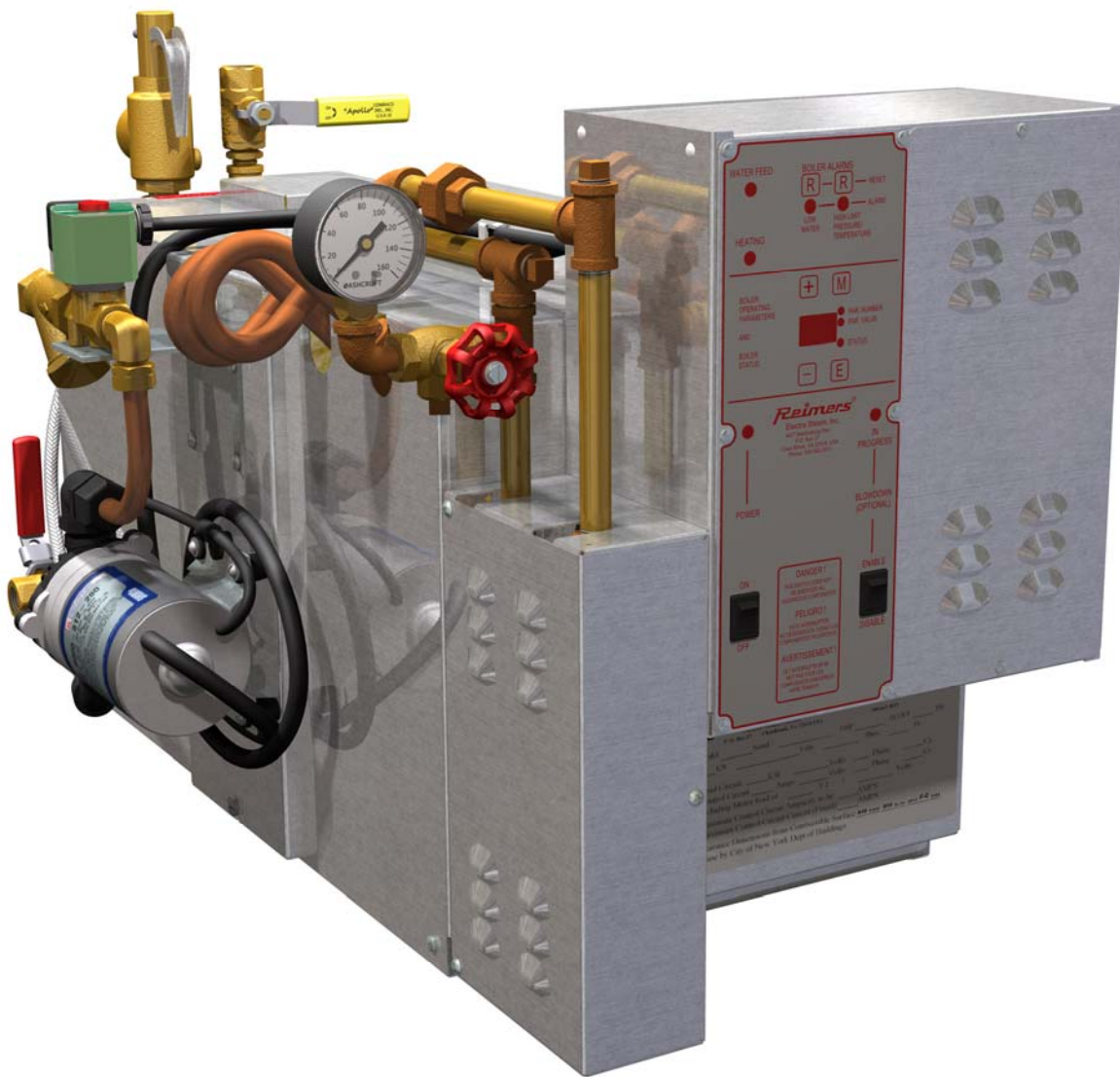
4407 Martinsburg Pike  
Clear Brook, VA 22624  
USA

Phone: 540-662-3811  
Fax: 540-665-8101  
email: [Sales@reimersinc.com](mailto:Sales@reimersinc.com)  
web: [www.reimersinc.com](http://www.reimersinc.com)

**MODEL:**

**SERIAL #:**

## R- RH- and RHC-Steam Boiler Models (RB-Series)



## Instructions Manual

## **LIMITED WARRANTY - STEAM BOILERS**

Reimers Electra Steam, Inc. warrants the following products of its own manufacture against defects in materials and workmanship under normal use and service. This warranty is in lieu and excludes all other expressed or implied warranties or merchantability of fitness for any particular use. No person is authorized to extend the terms of this warranty or assume any other liability except by written statement signed by an officer of Reimers Electra Steam, Inc. Clear Brook, Virginia 22624.

### **WARRANTY PERIOD**

The pressure vessel, electrical and mechanical components are warranted for one year from date of shipment from Reimers Electra Steam, Inc. in Clear Brook, VA 22624.

### **LIMITATIONS**

Products must be installed, used and maintained in accordance with our instructions, including reasonable and necessary maintenance by the user. Users are responsible for the suitability of the products to their application. There is no warranty damage resulting from improper installation, abuse, power failure, fire, flood, lightening, improper water, misuse, improper specification, misapplication or other operating conditions beyond our control or parts that are normally expendable in usual course of operation.

Claims against carriers for damage in transit must be filed by the buyer. Reimers liability, if any, will not exceed the price of Reimers products claimed to be defective.

Components manufactured by any supplier other than Reimers shall bear only that warranty made by the manufacturer of that product and service for that warranty shall be the responsibility of that manufacturer and not Reimers.

### **REMEDY**

Claims under this Limited Warranty must be made by obtaining a Return Authorization Number from our office (PHONE: 540-662-3811, FAX: 540-665-8101) and returning defective part, freight prepaid to: Reimers Electra Steam, Inc., 4407 Martinsburg Pike, Clear Brook, Virginia 22624.

Defective items will be repaired or replaced as necessary within a reasonable time without charge, other than incidental charges such as freight prepayment. Such repair or replacement within a reasonable time is the exclusive remedy available from Reimers Electra Steam, Inc., under this Limited Warranty.

### **CONSEQUENTIAL DAMAGES**

Reimers Electra Steam, Inc., is not liable for labor costs incurred in the removal, reinstallation, or unauthorized repair of product, or for damages of any type whatsoever, including incidental and/or consequential damages.

**THIS WARRANTY SUPERSEDES ALL PREVIOUS WARRANTIES.**



## Read this manual before installing and using this product. Failure to do so can result in serious injury or death.

You have just purchased a quality steam boiler designed to the ASME Boiler Code and registered with the National Board of Boiler Inspectors. Treat this industrial equipment with care and respect. It is safe when installed, maintained, and used properly. Read the instruction carefully and contact the factory if you have any questions.

This manual contains safety messages. Each of the safety messages are preceded by one of the following signal word panels:



Safety messages preceded by this label contain information, that if not followed will result in death or serious injury.



Safety messages preceded by this label contain information, that if not followed could result in death or serious injury.



Safety messages preceded by this label contain information, that if not followed could result in minor or moderate injury.



Messages preceded by this label contain important information, but are not hazard-related.

Ensure that this manual is available to the boiler operator at any time.

Read carefully all safety labels attached to the boiler. If any safety label was damaged during shipment, contact the factory immediately:

Ph. 540-662-3811; e-mail: [sales@reimersinc.com](mailto:sales@reimersinc.com)

### Important Safety Information



**1. BLOWDOWN VALVE:** This valve is utilized to blow impurities from the boiler chamber. When opened, a large volume of hot water and steam is discharged. Ensure that this valve is properly piped for such discharge. State and local codes must be met as applicable.

**2. ELECTRICAL:** All field wiring to the boiler must be in accordance with the National Electric Code and any local codes that may apply. Wiring must be made by a competent certified electrician. Use copper wire only.

**3. GAUGE GLASS:** The gauge glass protector guards must be on at all times. When replacing the glass, be sure that the unit is not under pressure and is cool to touch. The gauge glass should be replaced once per year. If cracks or wear is evident, replace the gauge glass immediately.

**4. MODIFICATION.MISUSE:** This boiler has been designed and constructed in accordance with the ASME Boiler Code. Any modification or misuse can result in a dangerous situation. Reimers Electra Steam, Inc. is not liable for any product that has been modified or improperly used.

**5. PRESSURE GAUGE:** The pressure gauge indicates the internal pressure of the boiler. It can fail. Periodically have your boiler inspector compare the gauge with a known gauge utilizing the test valve arrangement provided. Ensure that the boiler is cold, not pressurized and electrically disconnected.

**6. REGISTRATION:** Most states and cities require boiler registration and inspection. Check with your government authorities.

#### 7. INSTALLATION AND REPAIR:

Installation and repair work of this unit must be performed only by experienced personnel. Before commencing a repair, ensure that the boiler is cold, not pressurized and electrically disconnected. All standard electrical and steam safety precautions must be taken during testing.

**8. SAFETY VALVE:** The safety valve is designed to discharge hot steam when the set pressure is exceeded. Ensure that the discharge port is pointing toward the back of the unit away from the operator or any aisles. Test the safety valve periodically to ensure that it is operating properly. Test carefully at full pressure by lifting lever using pliers and “slapping” shut. Steam discharge can scald. Ensure no one is exposed.

#### 9. STEAM INSTALLATION:

Steam piping must be of black pipe, not galvanized. Work must be done by an experienced steam fitter. All state and local codes must be met as applicable.

#### 12. WATER:

Ensure that all electrical components are in a dry location, free from any possibility of water soaking. Electric foot switches must not be placed on a wet floor. They must be placed on dry surface not subject to steam or water.

# 1. Installation

REIMERS ELECTRA STEAM, INC. boilers are heated by one or more immersion type heating elements. Automatic controls are provided to maintain pre-set operating pressure and proper water supply. Safety features include automatic low water cutoff, automatic pressure control, safety valve and visible water level gauge. Each boiler is manufactured in accordance with ASME I Power Boiler Code Standards and is individually inspected and stamped by an authorized National Board Insurance Inspector. All boilers are registered with the National Board of Boiler and Pressure Vessel Inspectors.

## NOTICE

The ASME data plate is located at the rear end of the pressure vessel, behind the label stamped with NATIONAL BOARD NUMBER of the unit.

When boiler is received, make sure it has not been damaged in shipment.

### 1.1 Location

Place the boiler in a level position, close to the equipment which it is to supply. This will insure minimum heat losses and allow more economical piping arrangements. All steam lines should be insulated.

#### a.) Working space:

Electric boiler spacing is dictated by NFPA-70, Table 110.26 as follows:

Nominal Voltage To Ground (Volts)	Minimum Clear Distance		
	Condition 1	Condition 2	Condition 3
0 – 150	3ft (91.4cm)	3ft (914mm)	3ft (914mm)
151 – 600	3ft (91.4cm)	3.5ft (107cm)	4ft (122cm)

Note: Where the conditions are as follows:

**Condition 1** — Exposed live parts on one side of the working space and no live or grounded parts on the other side of the working space, or exposed live parts on both sides of the working space that are effectively guarded by insulating materials.

**Condition 2** — Exposed live parts on one side of the working space and grounded parts on the other side of the working space. Concrete, brick, or tile walls shall be considered as grounded.

**Condition 3** — Exposed live parts on both sides of the working space.

(a) *Dead-Front Assemblies.* Working space shall not be required in the back or sides of assemblies, such as dead-front switchboards or motor control centers, where all connections and all renewable or adjustable parts, such as fuses or switches, are accessible from locations other than the back or sides. Where rear access is required to work on non-electrical parts on the back of enclosed equipment, a minimum horizontal working space of 762 mm (30 in.) shall be provided.

#### b.) Alcove or closet installation per UL834:

The proper location of this boiler model with regard to combustible floor, as well as clearances for alcove installation is indicated on the boiler name plate as follows:

Model R, RH and RHC 8-30	Dimension in. (cm)						
	A	B	D	EL	ER	F	G
	18 (46)	A24 (A61)	18 (46)	18 (46)	18 (46)	C	-

Description of dimensions and symbols

**A** – Clearance above top of boiler

**B** – Clearance from front of boiler

**Prefix C** to numeral indicates suitability for closet or alcove installation

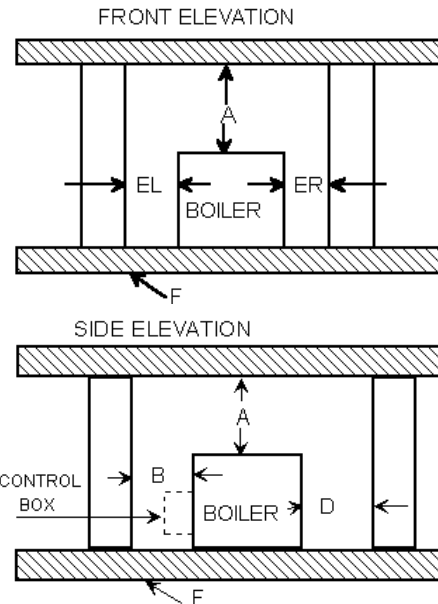
**Prefix A** indicates suitability for alcove but not for closet installation

**D** – Clearance from back of boiler

**EL** – Clearance from left side of boiler

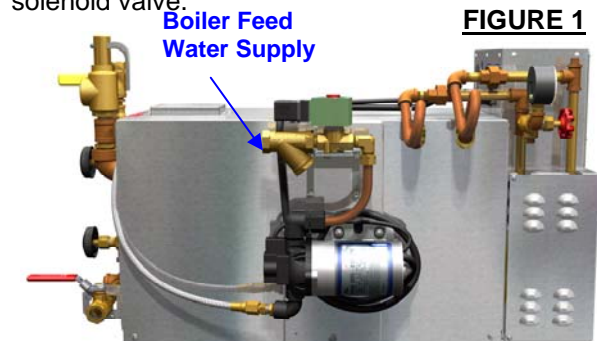
**ER** – Clearance from right side of boiler

**F** – Indicates type of flooring: "NC" for noncombustible floor / "C" for combustible floor. Numeral indicates minimum clearance below suspended units to combustible floor



### 1.2 Water Supply

On models with pump and/or solenoid valve, connect incoming water supply to strainer on intake side of solenoid valve.



On models furnished with condensate return tank, connect water line to makeup valve located at tank end. (See Instruction Supplement 1 in this manual)

R, RH and RHC steam boiler models require four (4) gallons of feed water per hour for each 10 kW of electric heating capacity of the boiler. Lines should be of adequate size and meet local plumbing codes.



In order to ensure long term trouble-free boiler operation, we recommend that the water used as boiler feed water to be tested for hardness. If the water in your area is harder than 1grain (17mg/L), use a water softener. The main cause for premature heating element failure in electric steam boilers is water hardness.

If severe corrosion during inspection of the pressure vessel as indicated in chapter 3.4 of this manual becomes evident, additional tests of your boiler feed water must be performed. A water analysis should be performed by a qualified and recognized water treatment company located in your area.

Recommended levels for boiler feed water:

WATER PROPERTY	MAX. LIMIT
Total hardness	17 mg/L
Dissolved Oxygen	0.04 mg/L
Total Iron	0.1 mg/L
Total Copper	0.05 mg/L
pH	> 8.5
Specific Resistivity	25kΩ * cm

Recommended levels for boiler water (water inside pressure vessel when boiler is operating)

PROPERTIES	MAX. LIMIT
Total Alkalinity	350 mg/L
Total Dissolved Solids	3500 mg/L
Total Suspended Solids	300 mg/L
pH	10.5 - 12

### NOTICE

Do not add any chemicals to the boiler feed water unless specifically recommended by a qualified and recognized water treatment company.

### 1.3 Steam Outlet

Connect steam line of sufficient size from steam outlet valve to the user's equipment.

### 1.4 Condensate Return

If the condensate is to be returned by gravity (no tank) in a closed system, the load discharge should be at least 2 feet (61cm) above the boiler level so that the weight of the condensate will actuate the check valve. When applicable, install steam return lines at sufficient height to allow a pitch of 2 inches (6cm) for every 10 feet (305cm) of pipe length.

### NOTICE

For condensate return systems (with tank), see Instruction Supplement 1 in this manual.

### 1.5 Safety Relief Valve

Ensure that the discharge port is pointing toward the back of the unit away from the operator or any aisles. If it is required that discharge piping be installed from the safety valve, the pipe should not be smaller than

the valve outlet and should be rigidly supported so as not to place weight on the valve itself.



**Do not install valves into the safety relief valve piping.**



**FIGURE 2**

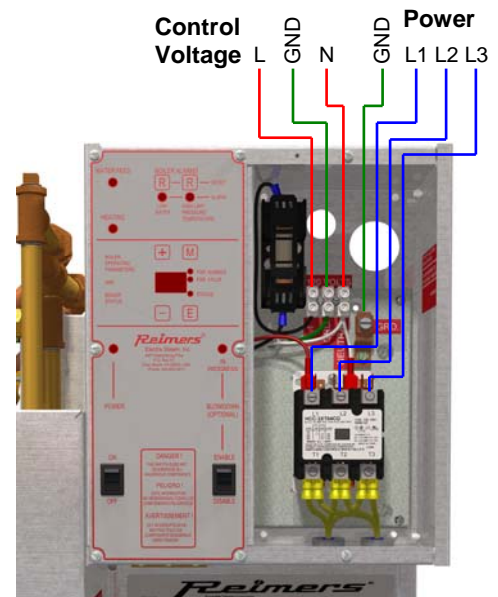
### 1.6 Electrical

Install a fused disconnect switch near the boiler. It should be fused as marked on the boiler name plate. Connect the power supply from the disconnect switch to the terminals in the boiler control panel as shown below. A copy of the wiring diagram is located in the control panel.



**Electrical connections to the boiler control panel should be made by a qualified electrician. All wiring must comply with local electrical codes.**

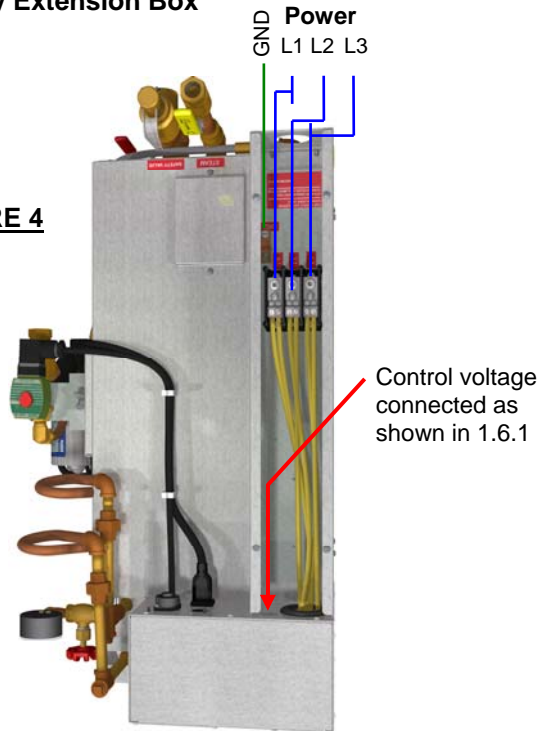
#### 1.6.1 Three-Phase Boiler Models Without Power Supply Extension Box



**FIGURE 3**

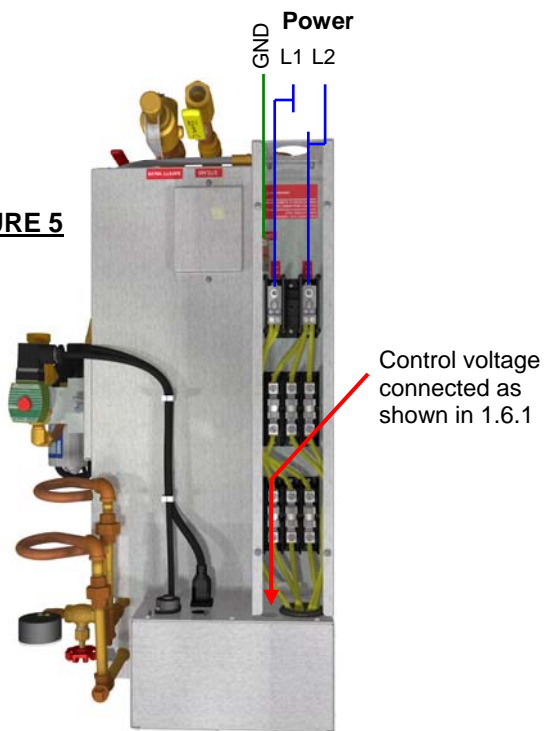
### 1.6.2 Three-Phase Boiler Models With Power Supply Extension Box

**FIGURE 4**



### 1.6.3 Single Phase Boiler Models with Power Supply Extension Box

**FIGURE 5**

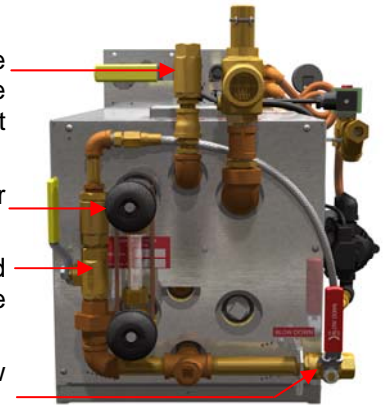


All boiler models that are equipped with a transformer option (OPT1009 or OPT1011) don't require a separate external control voltage power supply.

## 2. Operation

### 2.1 Boiler Startup

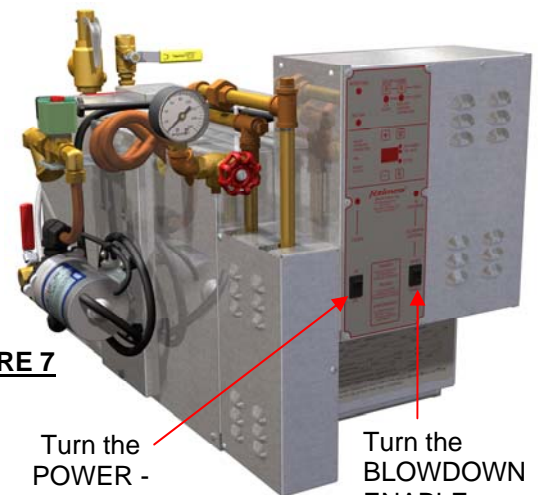
- Open steam line valve slightly. This will allow the boiler to be filled without producing back pressure.
- Open upper and lower gauge glass fixture valve
- Ensure that the feed water shutoff valve is in the OPEN-position
- Close the boiler blow down valve



**FIGURE 6**

- Throw the fused disconnect switch (not provided by factory) to the ON-position and turn on the boiler control voltage

d.)



**FIGURE 7**

Turn the POWER - switch ON

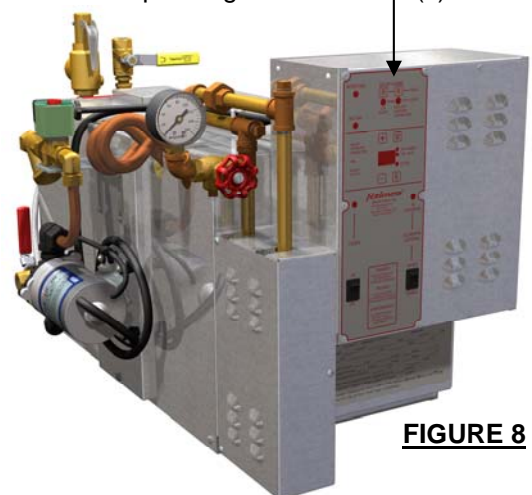
Turn the BLOWDOWN ENABLE switch OFF

After approximately 2 seconds, the WATER FEED light turns on and water enters the boiler. As soon as the water level reaches approximately half height in the gauge glass, the automatic water feed turns off.

### **NOTICE**

**Do not let the pump to run dry for an extended time as this will cause damage to the pump.**

- If the boiler controller indicates any alarms, then press the corresponding RESET button(s).



**FIGURE 8**

As soon as no boiler alarms are indicated, the HEATING light turns on and the boiler starts to build up pressure. Observe the pressure gauge while pressure builds up, until working pressure is reached. The working pressure should have been factory set to your specification. However, if you wish to change the working pressure setting, proceed as shown in chapter 3.2.

f.) To shut off boiler the boiler, turn the POWER switch on the boiler controller OFF.

## 2.2 Setting and Changing Boiler Operating Parameters on the Boiler Controller

Under normal conditions, there is no need to change the factory preset boiler operating parameters. However, if conditions such as low water or high water alarm nuisance tripping occurs, if the Automatic Flush & Drain duration needs to be changed and others, then one or more of the boiler operating parameters need some adjustment.

### 2.2.1 Boiler Controller Overview

The boiler controller provides all functions for the operation of the R, RH and RHC boiler models:

Basic Functions:

- Low water cutoff
- Boiler high pressure cutoff
- High water level feed shutoff
- Automatic boiler refill
- Automatic boiler blowoff (Optional)
- Remote controlled boiler ON/OFF and boiler status (Optional)

Automatic Refill Indicator Light  
 Boiler Alarm Reset Buttons  
 Element Heating Indicator Light  
 Boiler Controller Operator's Interface  
 Set boiler operating parameters during boiler operation; display indicates boiler status.

Power Switch and Indicator Light  
 This switch enables boiler operation when turned on.

**WARNING**  
 This switch does not de-energize all components of the control circuit!

Automatic Blowdown Switch  
 enables the optional blowdown valve actuator when installed. The indicator light indicates when boiler blowdown is in progress.

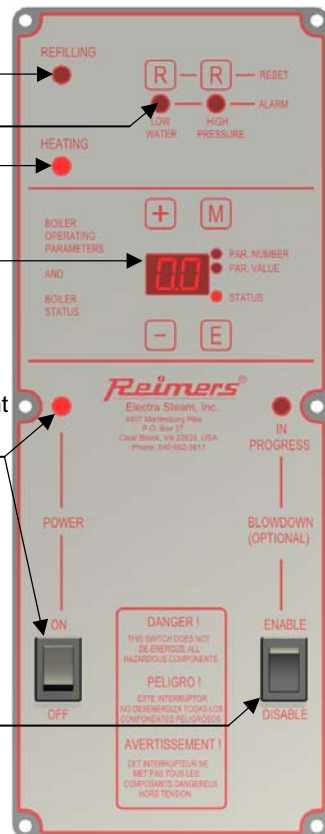


FIGURE 9

### 2.2.2 Low Water Cut-Off Function

The low water cutoff module of the boiler controller de-energizes the heating elements when the water level in the boiler pressure vessel falls below the minimum acceptable operating level. It senses the water level in the boiler pressure vessel with the low water cutoff probe E3.

The water level is processed by the low water cutoff module as normal when the tip of the probe E3 is in contact with water. When the water level in the boiler falls below the tip of the probe E3, then it is processed by the control as too low.


This control provides timing against short cycling, which avoids boiler shutdown when the probe E3 loses contact with the boiler water for a short period of time. Once the short cycling timer has elapsed (times are adjustable and can be set as shown below), the control de-energizes the heating elements and turns on the boiler alarm light "LOW WATER". This alarm light indicates that the water level in the boiler shell is too low and that the heating power is locked out. Boiler operation can be resumed only after restoring normal water level in the boiler shell and then pressing the "LOW WATER" reset (R) button. After pressing this button, the alarm light "LOW WATER" turns off and the lockout is removed.

An additional task of the low water cutoff module is to provide manual reset function for the high limit pressure control. If the operating pressure control fails, the steam pressure in the boiler pressure vessel can reach the value set on the high limit pressure control. In that case, the high limit pressure control de-energizes the heating elements. Lockout occurs as described above. The boiler alarm light "HIGH PRESSURE" remains on until the boiler steam pressure falls below the setting of the high limit pressure switch and the "HIGH PRESSURE" reset (R) button is pressed. After pressing this button, the alarm light "HIGH PRESSURE" turns off and the lockout is removed.

The default setting of the low water cutoff module is

Funct.	DIP-Switch	Description
1		Low water cutoff function. When the water level in the boiler pressure vessel is too low for more than $t_{lockout} = 3$ seconds, the low water cutoff module de-energizes and locks out the heating elements.
2		Same as Function1 plus automatic restart after boiler blowdown: Low water cutoff module allows after power on 10minutes boiler refill, while it keeps the heating elements de-energized. During this time no lockout is generated.
3		Same as Function1, but with adjustable time delay $t_{lockout}$ . Time range is 6 to 60seconds.



Funct.	DIP-Switch	Description
4		Same as Function2, but with adjustable time delay $t_{lockout}$ . Time range is 6 to 60seconds.

The R, RH and RHC steam boiler models ship with the low water cutoff module configured to Function 2. If low water alarm nuisance tripping occurs in the field usually caused by temporarily overloading the boiler, then change the module configuration to Function 3 by following the instructions below:

### **WARNING**

**Do not touch any electrical components of the boiler control circuit before turning OFF all power supplies to the boiler.**

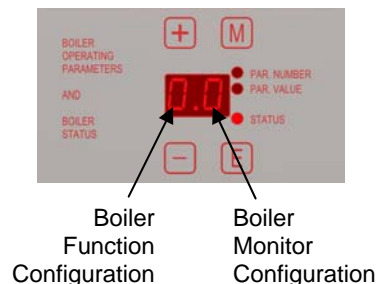
- 1 Turn the boiler controller POWER switch OFF. Turn all power supplies to the boiler OFF. Remove the four (4) upper screws from the front panel of the boiler controller and hinge the controller out from the electrical enclosure. On the low water cutoff module (the smaller electronic board) is located the 3-pole DIP-Switch which sets the low water cutoff module functions.
- 2 Move all DIP-switches into the ON-position. Hinge the boiler controller back into the electrical enclosure and attach the controller front panel at the upper left corner with one screw to the electrical enclosure.
- 3 Turn ON the control voltage power supply to the boiler and turn the POWER switch ON
- 4 Set Lockout Time  $t_{lockout}$ : (applicable only for Function 3 and Function 4)
  - a. Press and hold the “HIGH PRESSURE” reset (R) button
  - b. Press for 1 sec. and release for 1sec. the “LOW WATER” reset (R) button once for each 6seconds of delay time.
- 5 Turn the POWER switch off. Turn all power supplies to the boiler OFF. Remove the screw from the controller front panel upper left corner and hinge the controller out from the electrical enclosure.
- 6 Select Function 4 by sliding the DIP-switches as shown above
- 7 Hinge the boiler controller back into the electrical enclosure and attach the controller front panel with all screws to the electrical enclosure.
- 8 Turn the POWER switch ON for 4seconds
- 9 Turn the POWER switch OFF for 4seconds
- 10 Turn the POWER switch ON for 4 seconds.
- 11 Turn the POWER switch OFF for 4 seconds.
- 12 With the next POWER switch ON, the boiler is ready for operation.

### 2.2.3 Setting Boiler Operating Functions, Monitors and Parameters

Under normal conditions, there is no need to change the factory preset boiler operating parameters. However, if conditions such as high water level nuisance tripping or if optional additional equipment such as Automatic Flush & Drain, Alarm & Monitoring Interfaces and other equipment is installed in the field, then some boiler operating parameters must be

changed. This is performed by following the instructions below:

R, RH and RHC boiler models usually ship with the boiler controller configured set as shown. No adjustments to the boiler controller need to be made in order to operate the boiler.



The left display digit indicates the selected boiler function configuration, whereas the right display digit indicates the boiler monitoring configuration.

#### **Example:**

**The Boiler Function Configuration “0”** selected above indicates that the following boiler functions are enabled: “Automatic boiler refill function with single probe (E1)” with function parameters:

“Refill ON-delay time” = 0seconds (PAR. NUMBER 20)

“Refill OFF-delay time” = 3seconds (PAR. NUMBER 21)

And

“Pressure Controlled boiler blowdown function” with function parameter:

“Blowdown duration” = 4minutes (PAR. NUMBER 31)

Please refer to **Table1** for all available function configurations and detailed boiler function descriptions.

**The Boiler Monitor Configuration “0”** selected above indicates that the following boiler monitors are enabled:

“Automatic boiler refill monitor” with parameters:

“Initial automatic boiler refill timeout after power-on = 10minutes (PAR. NUMBER22)

“Automatic boiler refill timeout during boiler operation 1minute (PAR. NUMBER23)

And

“Boiler high water level cut-off monitor”

Please refer to **Table2** for all available boiler monitor configurations and their detailed description.

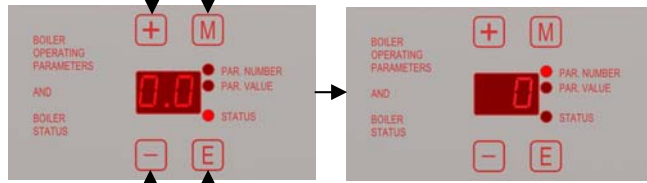
In order to make changes to the boiler controller configuration, proceed as follows:

a.) Before setting parameters, a pass code must be entered. This keeps unauthorized personnel from changing controller parameters. In order to enter the pass code, follow the steps below:

While the power switch is in ON-position, and the “STATUS”-LED is lit, press and hold the <-> and <E> keys at the same time. With <-> and <E> keys pressed, enter the following sequence on the <+> and <M> keys: <+>, <M>, <+>, <+> and <M>. Once the code is entered correctly, the light on the menu-LEDs toggle from “STATUS” to “PAR. NUMBER” and the controller is ready for boiler operating parameter changes.



Enter <+> <M> <+> <+> <M>



Press and hold these keys

b.) Press the <+> and/or <-> keys to set the boiler operating parameter number. When the parameter number is set, press the <M> key. This will toggle the light on the menu-LEDs from “PAR. NUMBER” to “PAR. VALUE” and the controller is ready for the selected boiler operating parameter value to be set.

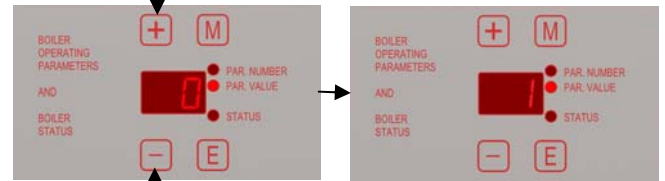
Increase parameter number



Decrease parameter number

c.) Press the <+> or <-> key to set the selected boiler operating parameter value.

Increase parameter value



Decrease parameter value

d.) To set the next boiler operating parameter, press the <M> key. Repeat item b.) and c.) until all required boiler operating parameters are set.

e.) To exit the boiler parameter setting menu, press the <E> key. Once the <E> key is pressed, the light toggles from the “PAR. VALUE”-LED to the “STATUS”-LED and the new boiler status is displayed.

The following Tables provide an overview of all available boiler and monitor function configurations (Table 1 and Table 2). Table 3 provides an overview of all operating parameters used in the boiler and monitor functions.

**Table 1: Boiler Function Configurations**

PAR. NUMBER	PAR. VALUE	PARAMETER DESCRIPTION
0	0	Boiler-Functions Configuration 0 disabled.
	1	Boiler-Functions Configuration 0 enabled = <b>“0” displayed in left digit of LED-Display.</b> Automatic boiler refill function with single probe (E1), refill ON-delay time = 0seconds, refill OFF-delay time = 3seconds. Pressure controlled boiler blowdown function (Automatic Flush & Drain) with blowdown duration = 4minutes. (Enable/disable this function with BLOWDOWN ENABLE switch on boiler controller)
1	0	Boiler-Functions Configuration 1 disabled.
	1	Boiler-Functions Configuration 1 enabled = <b>“1” displayed in left digit of LED-Display</b> Automatic boiler refill function with single probe (E1), refill ON-delay time = 0seconds, refill OFF-delay time = 10seconds. Pressure controlled boiler blowdown function (Automatic Flush & Drain) with blowdown duration = 4minutes. (Enable/disable this function with BLOWDOWN ENABLE switch on boiler controller)
2	0	Boiler-Functions Configuration 2 disabled.
	1	Boiler-Functions Configuration 2 enabled = <b>“2” displayed in left digit of LED-Display</b> Automatic boiler refill function with single probe (E1), refill ON-delay time = PAR. NUMBER20 (0 – 10seconds), refill OFF-delay time = PAR. NUMBER21 (3 – 11seconds). Pressure controlled boiler blowdown function (Automatic Flush & Drain) with blowdown duration = PAR. NUMBER31. (1 - 20 minutes), (Enable/disable this function with BLOWDOWN ENABLE switch on boiler controller)
3 - 9	0	Boiler-Function Configurations 3 - 9 disabled.
	1	Boiler-Function Configuration 3 - 9 enabled: No functions implemented yet.

## Boiler Function Definitions

### Automatic Boiler Refill Function with Single Probe (E1)

#### Sequence of Events:

As soon as the POWER switch on the boiler controller is turned off, the boiler controller de-energizes the boiler feed water pump and/or solenoid valve.

As soon as the POWER switch is turned on:

- As long as the water level-probe (E1) is in contact with the boiler water, the boiler controller keeps the boiler feed water pump and/or solenoid valve de-energized.
- As soon as the water level-probe (E1) loses contact with the boiler water, the boiler controller energizes the boiler feed water pump and/or solenoid valve after the elapse of the refill ON-delay time (PAR. NUMBER20).
- As soon as the water level-probe makes contact with the boiler water, the boiler controller de-energizes the boiler feed water pump and/or solenoid valve after the elapse of the refill OFF-delay time (PAR. NUMBER21).

### Pressure Controlled Boiler Blowdown Function

This function requires the Blowdown Valve Actuator and Blowdown Enable Pressure Control installed on the boiler.

#### Sequence of Events:

- As soon as the POWER switch on the boiler controller is turned on, the boiler controller de-energizes the Blowdown Valve Actuator (B2).
- With POWER switch turned off and as soon as the boiler pressure falls below the setting of the Blowdown Enable Pressure Control (S5), the boiler controller generates a 6second time delay. As soon as this time delay has elapsed, the boiler controller energizes (opens) the Blowdown Valve Actuator (B2) for a time (in minutes) saved in PAR. NUMBER31.
- After the time saved in PAR. NUMBER31 has elapsed, the boiler controller de-energizes (closes) the Blowdown Valve Actuator (B2).

**Table 2: Boiler Monitor Configurations**

PAR. NUMBER	PAR. VALUE	PARAMETER DESCRIPTION
10	0	Boiler-Monitoring Configuration 0 disabled:
	1	Boiler-Monitoring Configuration 0 enabled = <b>"0" displayed in the right digit of the LED-Display.</b> <b>Automatic boiler refill monitor.</b> Initial automatic boiler refill timeout after power-on = PAR. NUMBER22 (1 – 30minutes), automatic boiler refill timeout during boiler operation = PAR. NUMBER23 (1- 10minutes) <b>Boiler High Water Level Cut-Off Monitor.</b>
11	0	Boiler-Monitoring Configuration 1 disabled.
	1	Boiler-Monitoring Configuration 1 enabled = <b>"1" displayed in the right digit of the LED-Display.</b> <b>Boiler blowdown monitor.</b> Expected automatic boiler refill time after blowdown = PAR. NUMBER32 (0 – 99seconds). <b>Boiler High Water Level Cut-Off Monitor.</b>
12	0	Boiler-Monitoring Configuration 2 disabled.
	1	Boiler-Monitoring Configuration 2 enabled = <b>"2" displayed in the right digit of the LED-Display.</b> <b>Automatic boiler refill monitor.</b> Initial automatic boiler refill timeout after power-on = PAR. NUMBER22 (1 – 30minutes), automatic boiler refill timeout during boiler operation = PAR. NUMBER23 (1- 10minutes) <b>Boiler blowdown monitor.</b> Expected automatic boiler refill time after blowdown = PAR. NUMBER32 (0 – 99seconds). <b>Boiler High Water Level Cut-Off Monitor.</b>
13 - 19	0	Boiler-Monitoring Configuration 4 - 9 disabled.
	1	Boiler-Monitoring Configuration 4 - 9 enabled: No monitors implemented yet.

## Boiler Monitor Definitions

### Automatic boiler refill monitor:

**Flashing "0" in controller display = this boiler monitor generated an alarm. Press <E> to reset.**

#### Sequence of Events:

As soon as the POWER switch on the boiler controller is turned off, the automatic boiler refill monitor is disabled.

After the POWER switch is turned on, the automatic boiler refill-monitor measures the duration of each refilling cycle.

- If the feed water pump and/or solenoid valve remains energized for more than the time duration saved (in minutes) in PAR. NUMBER22, the boiler controller de-energizes the feed water pump and/or solenoid valve and displays a flashing "0" on the LED-display. The feed water pump and/or solenoid valve remains de-energized (off) until the "E"-key on the controller's key pad is pressed. As soon as the "E"-key is pressed, the boiler controller displays the current boiler function and monitor configurations again and starts a new refilling attempt. PAR. NUMBER22 should be set to approximately 1.5 x the time that the feed water pump and/or solenoid valve needs under normal operating conditions to fill the completely empty boiler to nominal water level.
- As soon as a refilling cycle is completed within the time saved in PAR. NUMBER22, the boiler controller will monitor all following refilling cycles as indicated above,

except that it will use the time duration saved (in minutes) in PAR. NUMBER23. PAR. NUMBER23 should be set to approximately 3 x the time that the feed water pump and/or solenoid valve needs under normal operating conditions to refill the boiler from minimum to nominal water level. Usually PAR. NUMBER22 is 4 to 5 times greater than PAR. NUMBER23.

### Boiler blowdown monitor

**Flashing "1" in controller display = this boiler monitor generated an alarm. Press <E> to reset.**

#### Sequence of Events:

As soon as the POWER switch on the boiler controller is turned on, the boiler blowdown monitor checks whether the boiler blowdown function completed a blowdown cycle while the POWER switch was turned off. If that was the case, then this monitor checks further whether the automatic refilling device (feed water pump and/or solenoid valve) remains on for the minimum expected time saved in PAR. NUMBER32. If the automatic refilling device turns off, before the time saved in PAR. NUMBER32 has elapsed; the boiler controller displays a flashing "1" on the LED-display. All boiler functions remain active. The flashing "1" indicates only that the last boiler blowdown attempt was not successful. As soon as the "E"-key is pressed, the boiler controller displays the current boiler function and monitor configurations again.

**Boiler High Water Level Cut-Off Monitor**

**Flashing “2” in controller display = this boiler monitor generated an alarm. Press <E> to reset, or alarm resets automatically (ref. to Sequence of Events below).**

This monitor requires the high water cut-off probe (E2) and steam solenoid valve (SOL2) installed and connected to the boiler. The steam solenoid valve is installed into the steam outlet line of the boiler.

**Sequence of Events:**

As soon as the high water level cut-off probe (E2) comes in contact with boiler water, the boiler controller turns off the automatic refilling device (feed water pump and/or solenoid valve). At the same time the boiler controller turns off the power to the heating elements, closes the steam outlet line through the solenoid valve (SOL2) and displays a flashing “2” on the LED-display. As soon as probe E2 losses contact with boiler water and PAR. NUMBER40 is set to “0”, the boiler controller resumes normal boiler operation automatically. If PAR. NUMBER40 is set to “1”, press the “E”-key to resume normal boiler operation.

**Table 3:**

20	0...10	Automatic boiler refill ON-delay time, in seconds.
21	0...11	Automatic boiler refill OFF-delay time, in seconds.
22	1...30	If PAR. NUMBER 10 = 1: Initial automatic boiler refill timeout after power-on, in minutes.
23	1...10	If PAR. NUMBER 10 = 1: Automatic boiler refill timeout during boiler operation, in minutes.
24		
25		
26		
27		
28		
29		
30	0	Pressure controlled boiler blow-off function (Automatic Flush and Drain) disabled.
	1	Pressure controlled boiler blow-off function (Automatic Flush and Drain) enabled.
31	1...20	Pressure controlled boiler blow-off duration (Automatic Flush and Drain), in minutes.
32	0...99	Expected automatic boiler refill time after blowdown, in seconds.
33		
34		
35		
36		
37		
38		
39		
40	0	Automatic alarm reset after high water cut-off alarm.
	1	Manual reset after high water cut-off alarm.

### 3. Boiler Maintenance

#### **⚠ WARNING**

Repair must be performed by experienced personnel only. Ensure boiler is cold and drained and has no pressure or electricity.

#### 3.1 Boiler Blowoff

All boilers must be blown off periodically to remove minerals, scale and other foreign matter, which accumulate inside the pressure vessel. The concentration of this deposit depends in part upon the condition of the water in the area. When water is naturally soft, or has been softened chemically, boiler blowoffs are required less often than in areas where hard water is found. Water softeners are suggested in hard water areas to minimize the formation of hard scale on heating elements. Another factor affecting water condition is the amount of condensate, if any, that is being returned to the boiler. Since condensate is essentially clean distilled water, it contains very few impurities. If a large part of the condensate is being returned and little make-up water is used, the boiler need not be blown down as often as when little or no condensate is returned to the boiler. We recommend blowoff of newly installed steam boilers once per day until the first heating element and pressure vessel inspection is performed (refer to chapter 3.4). If no significant amount of sediment is found on the bottom of the pressure vessel and on the heating element sheaths, then the boiler blowoff frequency can be reduced accordingly. The safest method to blowoff R-series steam boilers is to install a Reimers Electra Steam, Inc. properly sized and fully trimmed blowdown tank, model BTANK-10 (Figures 10 and 11). Reimers blowdown tanks are designed and constructed to Section VIII of the A.S.M.E. Code and inspected by a commissioned National Board Boiler inspector.

In addition to the boiler blowoff information provided in this manual, please

<http://www.youtube.com/watch?v=WhVLOuQywpl>

#### 3.1.1 Blowdown Tank Installation

Pipe the blowdown tank to the steam boiler (4), cold water line (1) and discharge (5) as shown in the Figures below. All piping must conform to the A.S.M.E. B31.1 Power Piping Code. The blowoff line between steam boiler and blowdown tank shall be made from black ½" NPT, SCH80 steel pipe and the pipe fittings shall be of black steel.

#### **⚠ CAUTION**

**Do not use galvanized piping as blowdown piping.**

The vent pipe must be 4" NPT, not longer than 50ft. and should be vented without any restrictions to the atmosphere with a minimum of turns. Pipe the blowdown tank discharge line (5) to a safe place of discharge.

Boiler blowoff can be performed either manually (Figure 10) or fully automatic (Figure 11).

Reimers Electra Steam, Inc. offers two fully automatic boiler blowoff options:

a.) Cost efficient boiler pressure triggered blowoff (Automatic Flush & Drain) package, model OPT1016 for applications in which the boiler operates during daytime and is shutdown during nighttime.

b.) Timer triggered blowoff package, model OPT1001 when boiler operates 24/7

If one of the fully automatic blowoff options is installed and the blowdown tank drains directly to the sewer, we recommend the installation of the automatic after cooler package; model OPT1027 into the blowdown tank drain line.

#### 3.1.2 Boiler Blowoff Frequency

In areas where water is soft or has been softened chemically:

- When little condensate is returned blowdown once every second day
- When a large part of the condensate is returned and little make-up water is used, blowdown once every week

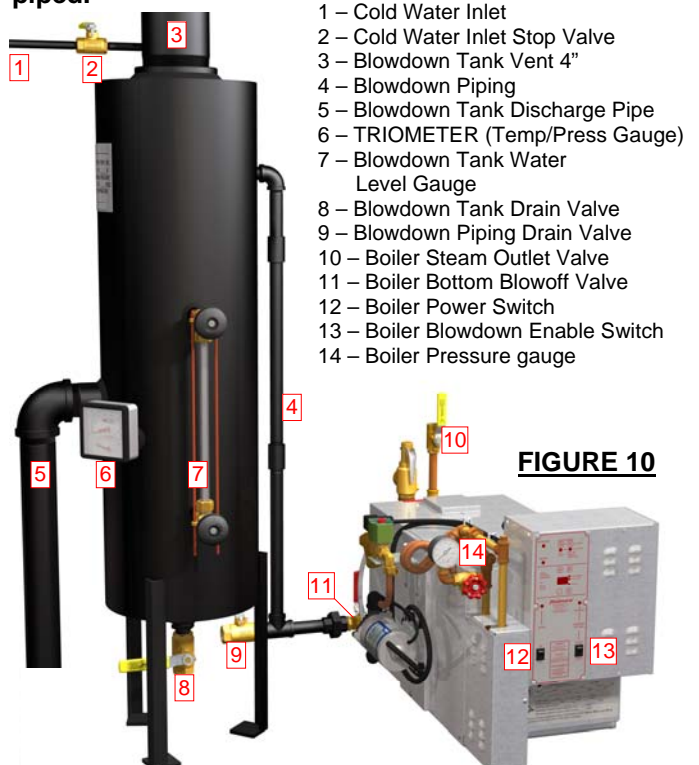
In areas where hard water exists:

- When little or no condensate is returned, blowdown once a day
- When a large part of the condensate is returned and little make-up water is used, blowdown once every second day

#### 3.1.3 Manual Blowdown Procedure

#### **⚠ CAUTION**

**Stand clear of scalding water or steam. Ensure that the Boiler Bottom Blowoff Valve is properly piped.**



**FIGURE 10**



**Step**                      **Action**

- 1 If the blowdown tank is empty, ensure that the Blowdown Tank Drain Valve (8) and Blowdown Piping Drain Valve (9) are closed.
- 2 If the water level in the Blowdown Tank Water Level Gauge (7) is below the half height of the glass, open the Cold Water Inlet Stop Valve (2) and refill the tank until water flows out of the Blowdown Tank Discharge Line (5). Close the Cold Water Inlet Stop Valve (2).
- 3 Ensure that the TRIOMETER (6) indicates a tank temperature of 70°F or less. If the tank temperature is still above 70°F, then either wait until the temperature drops or open the Cold Water Inlet Stop valve (2) and discharge water from the tank, until the above temperature is reached.
- 4 Close the Boiler Steam Outlet Valve (10) and ensure that the Boiler Pressure Gauge (14) indicates more than 5psig.
- 5 Turn the Boiler Power Switch (12) to the OFF - position
- 6 Open slowly the Boiler Bottom Blowoff Valve (11) and leave the valve open approximately for the times shown below, depending on the steam pressure that was indicated by the Boiler Pressure Gauge (14) before opening the Boiler Bottom Blowoff Valve (11):

Boiler Pressure PSIG	Boiler Blowoff Time seconds
5	60
20	50
40	40
60	30
80	20

Observe the tank temperature during the boiler blowoff action. Close the Boiler Bottom Blowoff Valve (11) as soon as the temperature indicated on the TRIOMETER (6) approaches 140°F, regardless of whether the above shown Boiler Blowoff Time could be completed.

If the TRIOMETER (6) indicates a pressure higher than 5PSIG, close the Boiler Bottom Blowoff Valve (11) immediately. Check for restrictions in the Blowdown Tank Vent (3).

- 7 Close the Boiler Bottom Blowoff Valve (11)
- 8 Open slowly the Boiler Steam Outlet Valve (10) and turn the Boiler Power Switch (12) to the ON-position. The boiler will begin refilling automatically to its nominal water level and then will start heating. Close the Boiler Steam Outlet Valve (10) after the HEATING-light on the boiler controller turns ON. This will prevent the build-up of vacuum in the boiler pressure vessel after refilling with cold water.
- 9 As soon as the boiler reaches its set steam pressure, open slowly the Boiler Steam Outlet Valve (10) and resume boiler operation.

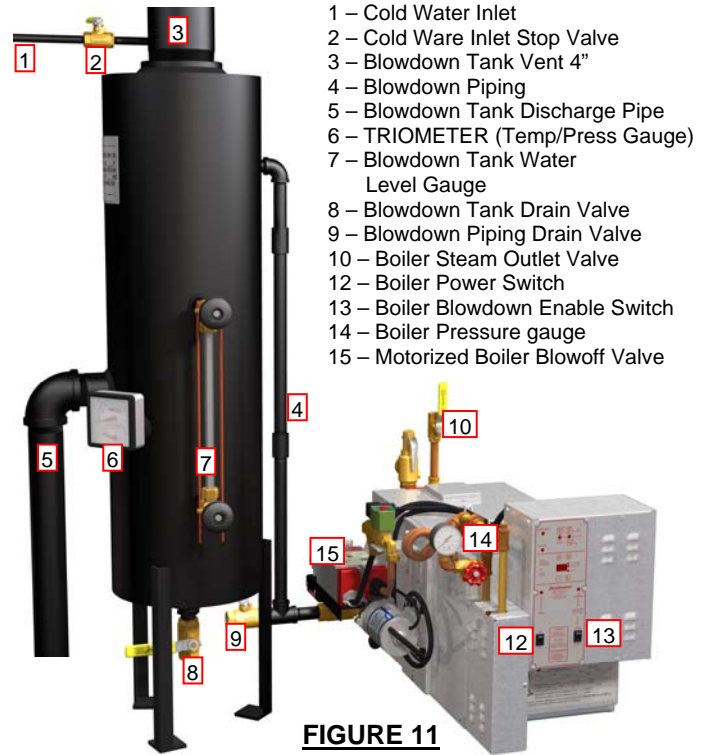
**CAUTION** After boiler blowoff, the outer wall of the blowdown tank is hot. Do not touch!

- 10 Approximately two (2) hours after boiler blowoff, open the Blowdown Piping Drain Valve (9) until all water is drained from the horizontal run of the Blowdown Piping (4).
- 11 Close the Blowdown Piping Drain Valve (9).

**3.1.4 Automatic Blowdown Procedure**

**CAUTION**

Stand clear of scalding water or steam. Ensure that the Motorized Boiler Blowoff Valve is properly piped.



**FIGURE 11**

**Step**                      **Action**

- 1 If the blowdown tank is empty, ensure that the Blowdown Tank Drain Valve (8) and Blowdown Piping Drain Valve (9) are closed.
- 2 If the water level in the Blowdown Tank Water Level Gauge (7) is below the half height of the glass, open the Cold Water Inlet Stop Valve (2) and refill the tank until water flows out of the Blowdown Tank Discharge Line (5). Close the Cold Water Inlet Stop Valve (2).
- 3 Ensure that the TRIOMETER (6) indicates a tank temperature of 70°F or less. If the tank temperature is still above 70°F, then either wait until the temperature drops or open the Cold Water Inlet Stop valve (2) and discharge water from the tank, until the above temperature is reached.
- 4 Close the Boiler Steam Outlet Valve (10) and ensure that the Boiler Pressure Gauge (14) indicates more than 5psig.
- 5 Turn the Boiler Power Switch (12) to the OFF - position and the Boiler Blowdown Enable Switch (13) to the ON-position.
- 6 If the boiler is equipped with a 15psig safety relief valve, the Motorized Boiler Blowoff Valve (15) will open automatically approximately 6 seconds after the Boiler Power Switch (12) turns OFF. If the boiler is equipped with a 100psig safety relief valve, the boiler steam pressure must drop below the setting of the Pressure Triggered Boiler Blowoff Pressure Switch (see chapter 3.2) before the Motorized Boiler Blowoff Valve (15) opens automatically.

- 7 Once the Motorized Boiler Blowoff Valve opens, it remains open for the pre-set time saved in the boiler controller parameter #31. The default value of parameter #31 = 4 minutes. If a shorter or longer boiler blowoff duration is required, then set the boiler controller to boiler function configuration #2 (see chapter 2.2.3 for setting boiler operating parameters) and set parameter #31 to the desired boiler blowoff duration in minutes.
- 8 As soon as the boiler blowoff duration has elapsed, the Motorized Boiler Blowoff Valve (15) closes automatically.
- 9 Open slowly the Boiler Steam Outlet Valve (10) and turn the Boiler Power Switch (12) to the ON-position. The boiler will begin refilling automatically to its nominal water level and then will start heating. Close the Boiler Steam Outlet Valve (10) after the HEATING-light on the boiler controller turns ON. This will prevent the build-up of vacuum in the boiler pressure vessel after refilling with cold water.
- 10 As soon as the boiler reaches its set steam pressure, open slowly the Boiler Steam Outlet Valve (10) and resume boiler operation.

**CAUTION** After boiler blowoff, the outer wall of the blowdown tank is hot. Do not touch!

- 11 Approximately two (2) hours after boiler blowoff, open the Blowdown Piping Drain Valve (9) until all water is drained from the horizontal run of the Blowdown Piping (4).
- 12 Close the Blowdown Piping Drain Valve (9).

### 3.1.5 Boiler Blowdown Tank Maintenance

**CAUTION** After boiler blowoff, the outer wall of the blowdown tank is hot. Do not touch!

All sediment that is removed from the boiler pressure vessel during boiler blowoff will collect at the bottom of the blowdown tank. Periodically, these sediments must be removed. To accomplish this, proceed as follows:

- a. Draining and rinsing the blowdown tank after every five boiler blowoffs or after one week:
  - Ensure that the Blowdown Tank Drain Valve (8) drains to the sewer and if necessary pipe the valve, using one or two pipe unions that allow easy removal of the piping from the drain valve when manual cleanout of the blowdown tank is required (see item b. below).
  - Ensure that the tank water temperature is below 140°F.
  - Open the Blowdown Tank Drain Valve (8) and wait until the tank is completely empty
  - Open the Cold Water Inlet Stop Valve (2) for approximately 5 minutes
  - Close both valves (2) and (8)
- b. Manual cleaning of the blowdown tank after every twelve (12) months of operation:
  - Ensure that the tank water temperature is below 140°F.

- Open the Blowdown Tank Drain Valve (8) and wait until the tank is completely empty
- Disconnect the Blowdown Tank Drain Valve (8) from the drain piping
- Remove the Blowdown Tank Drain Valve (8) and the bushing from the bottom of the blowdown tank. This will give access to a 2" NPT opening.



**FIGURE 12**

- Remove any sediments that have accumulated at the bottom of the blowdown tank
- Re-install the Blowdown Tank Drain Valve (8) and its piping.

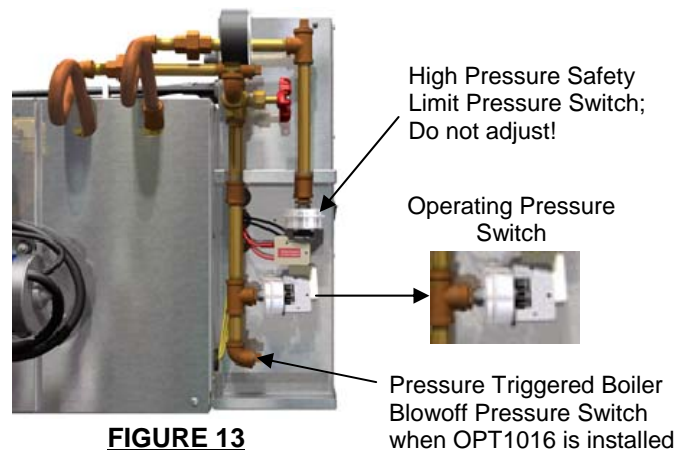
### 3.2. Pressure Adjustment

**WARNING**

Stand clear of scalding water or steam. Disconnect the boiler from all power supplies.

All pressure controls are factory preset and require no adjustment. However, if a change of the operating steam pressure is required, then proceed as follows:

- Disconnect all power supplies from the boiler.
- Close the steam outlet valve
- Remove the cover from the pressure control enclosure.
- Turn the black knob of the operating pressure switch clockwise to increase the pressure and counterclockwise to decrease the pressure.



**FIGURE 13**

- Connect all power supplies to the boiler, open the steam outlet valve, and install the pressure control enclosure cover.

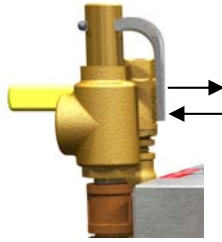
### 3.3 Safety Valve Test

**CAUTION**

Stand clear of safety valve and scalding steam.

This test should be performed once per month. Proceed as follows:

- Increase the steam pressure as shown in chapter 3.2. to maximum operating pressure.
- Keep the steam outlet valve closed
- Pull the trip lever and hold open for five (5) seconds in order to flush off the valve seat.



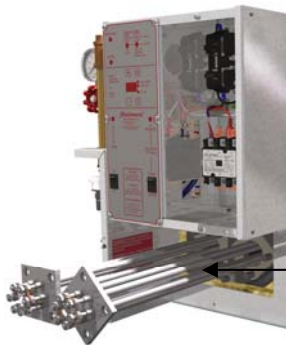
**FIGURE 14**

- Permit the valve to “slap” shut. If a leak occurs, repeat this test and if necessary, replace the valve

### 3.4 Element Replacement and Element Cleaning



**Ensure that the boiler is cold, drained and all power supplies are disconnected.**



Element Rods

**FIGURE 15**

Clean the element rods every six (6) months. To clean the element rods, or if an element must be replaced, proceed as follows:

- Remove the element terminal cover from the front of the boiler.
- Disconnect and label the terminal wires
- Remove all four (4) nuts from each element flange and pull out the heating element
- Use a stiff wire brush to remove all scale and foreign matter from the element rods.
- Clean the element flange surfaces before installing new elements and gaskets

### 3.5 Water Level Probe and Probe Baffle Box Cleaning



**Ensure that the boiler is cold, drained and all power supplies are disconnected.**

In order to provide reliable automatic water level control, the water level probes are located inside a funnel shaped probe baffle, welded to the inner wall of the pressure vessel. The probe baffle has direct connection to the top and bottom of the pressure vessel so that the probes can read the water level, protected from foam and bursting steam bubbles that form on the surface of the boiler water. The probe baffle must be cleaned every six (6) months of sediments and other debris that accumulates at the bottom of the baffle. To accomplish this, proceed as follows:

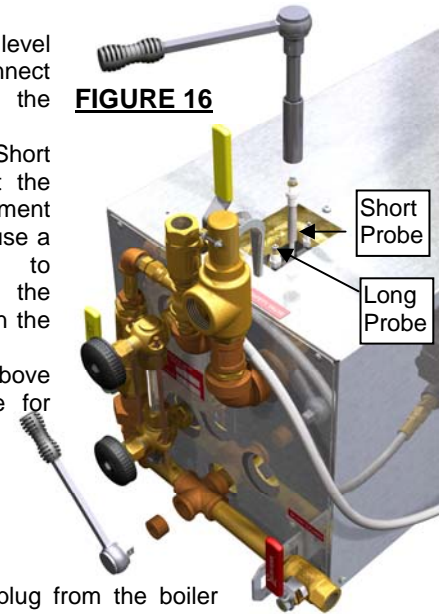
#### Step 1:

Remove the water level probe cover, disconnect from each probe the wire and label it.

Remove first the Short Probe and inspect the probe rod. If sediment has accumulated, use a stiff wire brush to remove it. Install the probe in its place in the shell.

Repeat the above cleaning procedure for the other probes. Don't install the Long Probe yet.

**FIGURE 16**



#### Step 2:

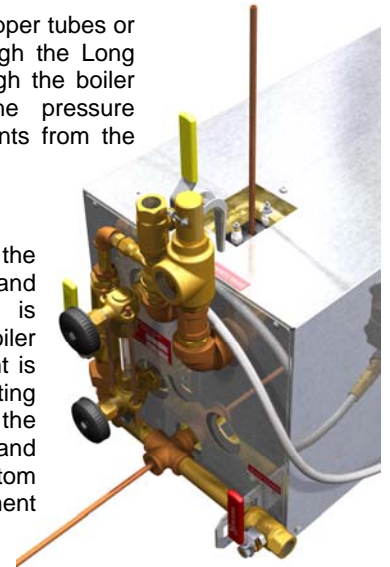
Remove the pipe plug from the boiler blowoff line as shown in FIGURE 16.

#### Step 3:

Insert two (2) 1/4in OD copper tubes or any other soft rods through the Long Probe opening and through the boiler blowoff opening into the pressure vessel to remove sediments from the bottom of the probe baffle.

#### Step 4:

Put a flash light above the Long Probe opening and observe whether light is visible through the boiler blowoff opening. If no light is visible, then repeat inserting the copper tube through the Long Probe opening and pushing towards the bottom to remove further sediment from the probe baffle.



If there is a significant amount of sediment visible at the bottom of the pressure vessel, then the heating elements must be removed as shown in chapter 3.4 and the sediments scooped out through the element openings.

#### Step 5:

Install the Long Probe into the shell and connect all probe wires.

### 3.6 Feed Water Pump Replacement



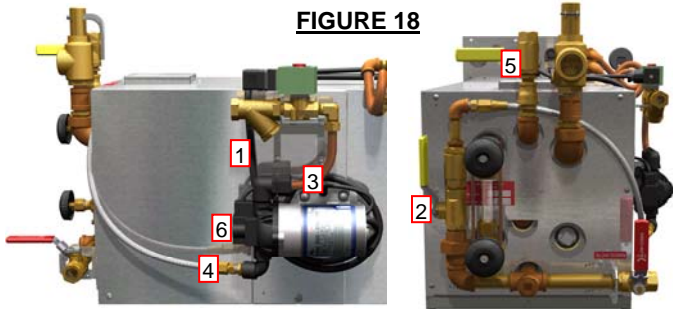
**Ensure that all power supplies are disconnected and that there is no pressure in the boiler.**

When replacing the feed water pump on RH-models, proceed as follows (ref. FIGURE 18):

- Unplug the Pump Power Cord (1) of the pump that needs to be replaced
- Close the Feed Water Shutoff Valve (2)
- Disconnect the Pump Ports from the Solenoid Valve (3) and Boiler Water Feed Line (4)



- Unscrew the pump from the pump plate
- Install the new pump
- Open the Feed Water Shutoff Valve (2)
- Turn ON all power supplies to the boiler
- Turn ON the “POWER” – switch of the boiler controller. Observe the water level in the gauge glass and ensure that the pump fills the boiler to its nominal water level
- Close the Boiler Steam Outlet Valve (5) and wait until the boiler reaches its set operating steam pressure



**FIGURE 18**

- Test the setting of the Pump Pressure Switch (6) by:
  - a. Discharge steam through the steam outlet valve

**⚠ CAUTION**

**Before discharging steam, ensure that the steam outlet valve is properly piped.**

Open the boiler steam valve, discharge steam and wait until the “REFILLING”-light on the boiler controller turns on. The pump must turn on as soon as the “REFILLING”-light on the boiler controller is on. If pump does not turn on when the “REFILLING” light turns on, use 2mm Allen wrench and turn pump pressure switch set screw CW until pump turns on. As soon as pump turns on, turn pump pressure switch set screw an additional half turn CW.

- b. Discharge boiler water through the boiler blowoff valve

**⚠ CAUTION**

**Before opening the boiler blowoff valve, ensure that it is properly piped.**

Open slowly the boiler blowdown valve and drain boiler water until the “REFILLING”-light on the boiler controller turns on. The pump must turn on as soon as the “REFILLING”- light on the boiler controller is on. If pump does not turn on when the “REFILLING” light turns on, use 2mm Allen wrench and turn pump pressure switch set screw CW until pump turns on. As soon as the pump turns on,

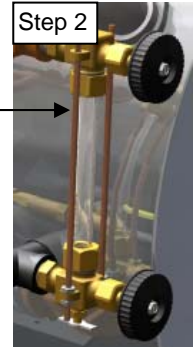
turn the pump pressure switch set screw an additional half turn CW.

### 3.7 Gauge Glass Replacement

Frequency: Minimum once per year.



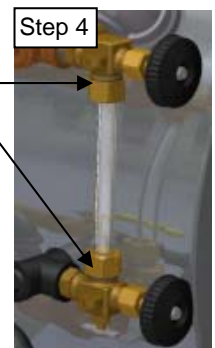
**FIGURE 19A**



**FIGURE 19B**



**FIGURE 19C**



**FIGURE 19D**



**FIGURE 19E**

**Step 6**  
Install new glass by performing the above procedure in reverse order. Always install new rubber washers.



## 4. Trouble Shooting



**Ensure that the boiler is cold and has no pressure.  
Electrical trouble shooting must be performed by a qualified electrician.**

Boiler Status	Quick Fix
POWER switch on boiler controller turned on, but no lights lit on the front panel of the boiler controller	<ul style="list-style-type: none"> <li>- Check circuit breaker or fuse of the wall outlet where the boiler control voltage circuit is hooked up to. If the circuit breaker is tripped or the fuse blown, check whether other appliances are plugged into outlets that are fed by the same circuit breaker/fuse. If that is the case, then plug those other appliances into outlets that are protected by other circuit breakers or fuses.</li> </ul>
LOW WATER alarm light on boiler controller panel lit:	<ul style="list-style-type: none"> <li>- Press the LOW WATER reset button</li> <li>- Check Water Level. Water level must be visible in gauge glass.</li> <li>- Ensure that the boiler is filled with Tap water and not distilled or de-mineralized water.</li> <li>- Check the probe wires for continuity</li> </ul>
HIGH PRESSURE alarm light on boiler controller panel lit:	<ul style="list-style-type: none"> <li>- Press the HIGH PRESSURE reset switch</li> <li>- If the pressure gauge indicates steam pressure above the preset value, reduce pressure and press the HIGH PRESSURE reset switch again.</li> </ul>
Unit won't build up pressure when POWER switch is on, boiler filled to nominal water level with water and HEATING light on the boiler controller is lit.	<ul style="list-style-type: none"> <li>- Voltage Test: Read voltage across each element. If no voltage reading, check the voltage before and after the element contactor. If no voltage before the contactor, check fuses in fused disconnect switch. If no voltage reading after the contactor and contactor pulled in, replace contactor. If voltage reading after the contactor, go to Amperage Test.</li> <li>- Amperage Test: Read amperage on each element wire. If no amperage reading on one or more element wires, replace heating elements.</li> </ul>
Pump and/or solenoid valve energized, but no water enters the boiler	<ul style="list-style-type: none"> <li>- Check water inlet strainer</li> <li>- Check whether the water feed shutoff valve is open</li> </ul>
Boiler overfills or floods	<ul style="list-style-type: none"> <li>- Check water feed solenoid valve for sticking</li> <li>- Check the probe wires to the boiler controller for continuity</li> <li>- Check feed water. Boiler won't operate with distilled or de-mineralized water</li> </ul>
Fuse blown	<ul style="list-style-type: none"> <li>- Short circuit or overload has occurred. Before replacing fuse, locate the short circuit or overload.</li> <li>- Poor contact between fuse and fuse clips can cause fuse to blow. If surface that makes contact with the fuse clips is discolored, fuse has been making poor contact with the clips. Installing a larger fuse will not help. Replace the fuse holder.</li> </ul>
Contactor(s) don't pull in	<ul style="list-style-type: none"> <li>- Ensure that the contactor coil is receiving proper voltage</li> <li>- If contactor pulls in but chatters, clean magnetic core of contactor</li> <li>- Further problems would indicate mechanical difficulties within the contactor.</li> <li>- Complete contactor replacement is usually the least expensive solution</li> </ul>
"REFILLING" light on the boiler controller is lit, but feed water pump not energized	<ul style="list-style-type: none"> <li>- Check for proper contact of the pump power cord to the receptacle</li> <li>- Check for proper setting of the pump pressure switch. (Refer to chapter 3.6)</li> </ul>

If trouble shooting did not resolve problem, please contact our service technicians at:

Phone: 540-662-3811

Email: [sales@reimersinc.com](mailto:sales@reimersinc.com)

LIVECHAT [www.reimersinc.com](http://www.reimersinc.com)

# Instruction Supplement 1

## Condensate Return System

### I1. Installation

Step 1: Connect water supply to water intake on tank (1). If the city water line pressure exceeds 40psi, install a pressure reducing valve.

#### **NOTICE**

**Water supply should be turned off when the boiler is not in operation.**

Step 2: Connect the condensate return line from the equipment to the condensate return intake (2). Pipe from the vent (3) is to be installed to outside of the building, if desired. If this method is used, the pipe should be the same size as the vent opening.

**⚠ WARNING Under no condition should the vent be plugged.**

Step 3: Install piping from the overflow (4) to a drain.

### I2. Startup

Step 1: Turn all boiler power supplies on.

Step 2: Open the water supply valve to begin filling the condensate tank with water. Observe the water level in the tank gauge glass. When the float valve inside the tank closes, the water level should be still visible in the upper portion of the gauge glass.

Step 3: Open the boiler steam outlet valve (9).

Step 4: Ensure that the feed water shutoff valve (5) and the condensate pump supply valve (6) are in the open position.

Step 5: Flip the POWER-switch (7) to the ON-position. The pump should turn on.

Step 6: Open the pump primer valve (8) slightly and wait until water discharges. Close this valve.

Step 7: Wait until the pump stops. After the pump has stopped, the water level in the boiler gauge glass should be at approximately half height of the glass.

Step 8: Close the steam outlet valve (9) and wait until the boiler builds up pressure to its preset value.

Step 9: Open slowly the steam outlet valve (9) to supply steam to the process.

### I3. Maintenance

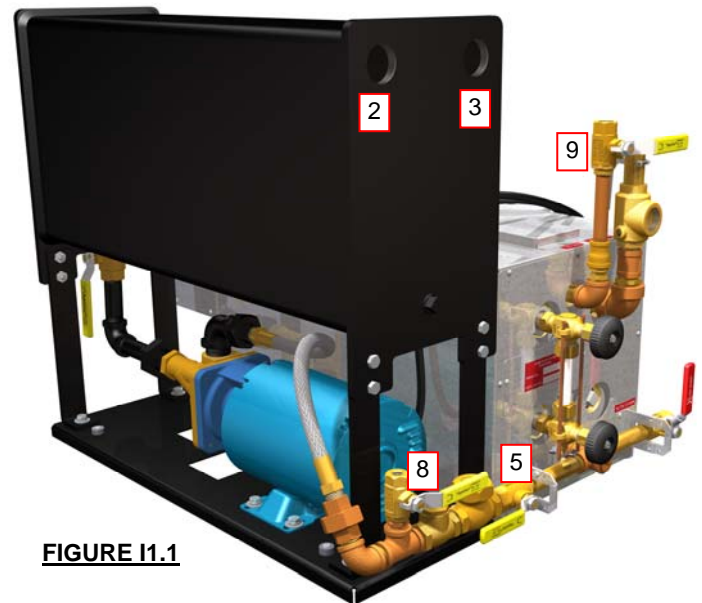
**a. Strainer** – The strainer (10) should be removed and cleaned shortly after boiler has been in operation to clear away sediment, which may have accumulated during start-up. This strainer should be periodically inspected and cleaned when necessary.

**b. Gauge Glass** - See Boiler Instructions.

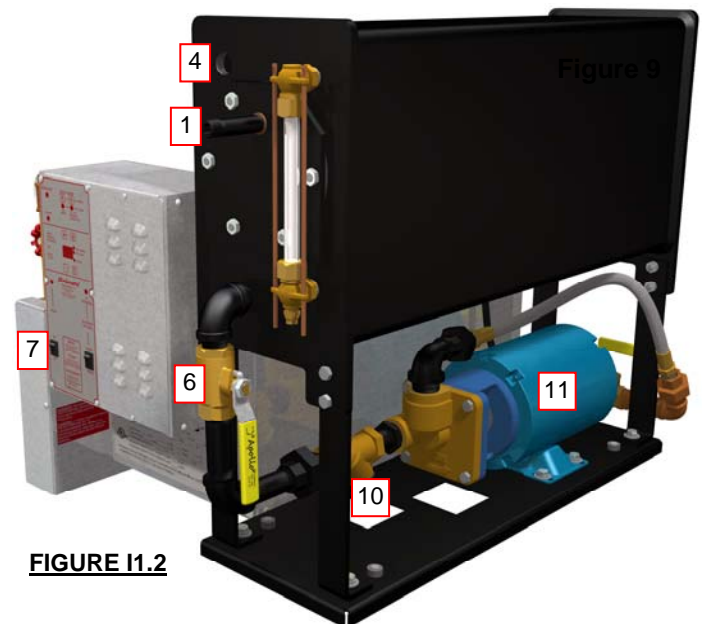
**c. Pump Motor** - Maintenance is normally not required on the pump or motor (11).

### I4. Condensate Return System Parts List

Part#	Description
02005	Gauge Glass 5/8" X 7"
02001	Gauge Glass Fixture Set
02027	Strainer 1"
02358	Screen for Strainer
02360	Pump/Motor 120/240 1/3PH 1/3 HP
02024	Complete Make-up Valve Assembly
02070	Make-up Valve
02085	Float Ball
02086	Gasket



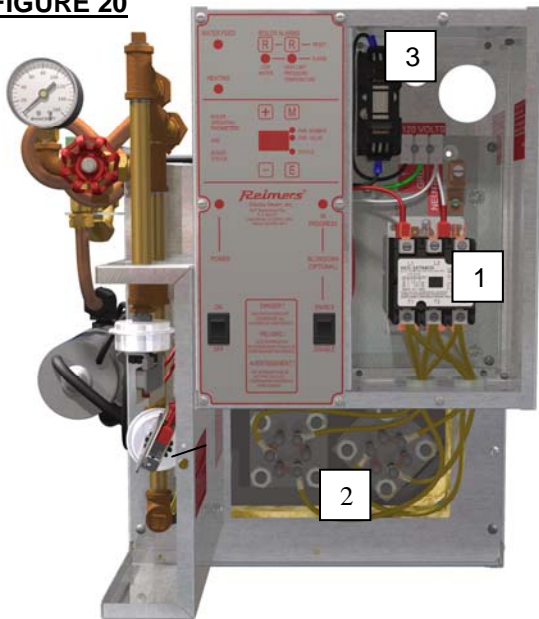
**FIGURE I1.1**



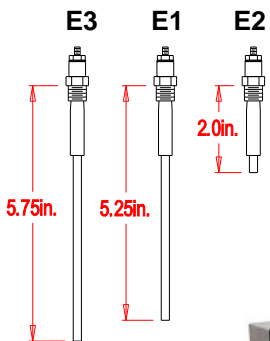
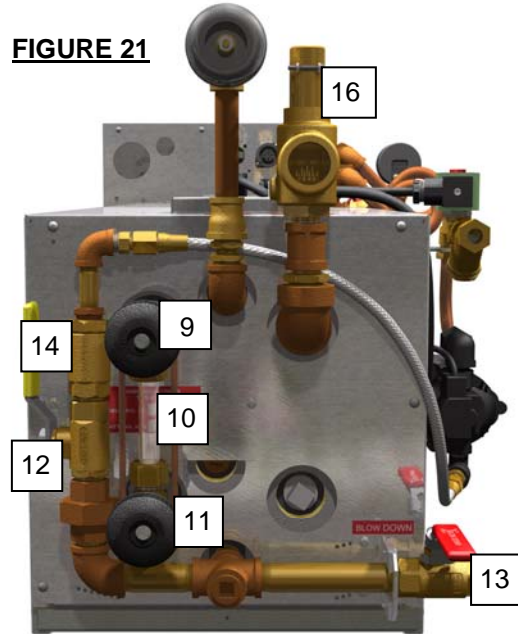
**FIGURE I1.2**

## Parts List for R, RH and RHC Boiler Models (RB-Series)

**FIGURE 20**

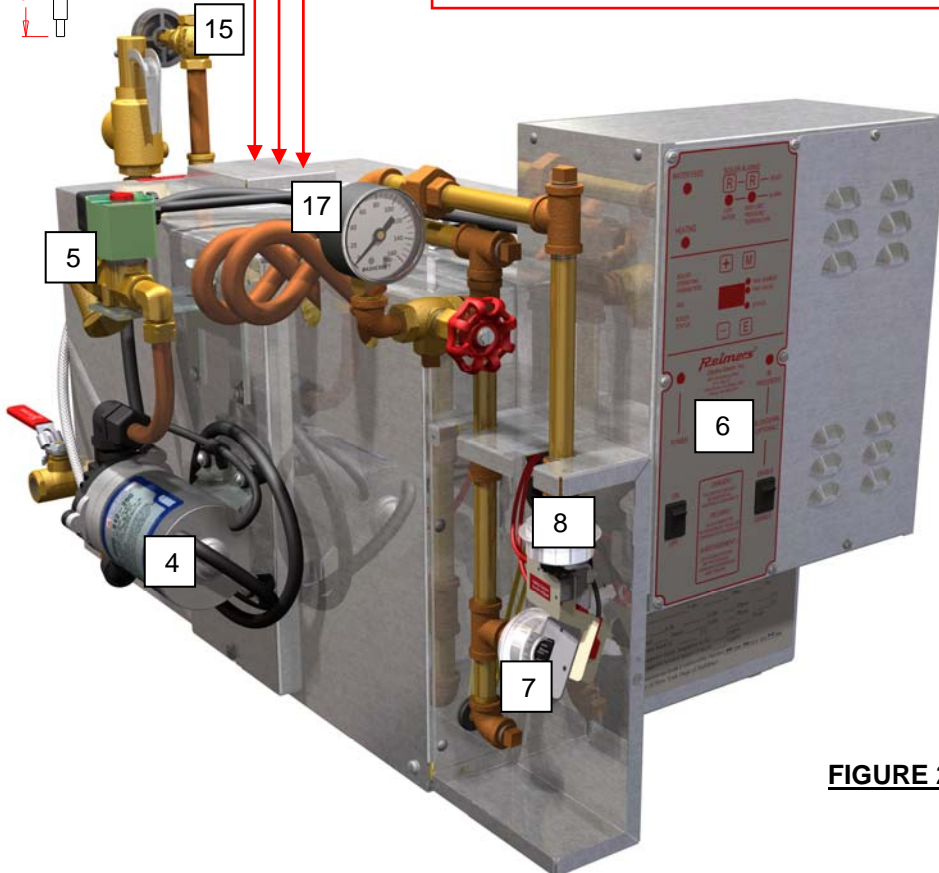


**FIGURE 21**



**Figure 22**

Low Water Cut-Off Probe (E3): Connect this probe to wire marked "14"  
 Automatic Refill Probe (E1): Connect this probe to wire marked "13"  
 High Water Level Cut-Off Probe (E2): Connect this probe to wire marked "10"  
 Please refer also to the boiler wiring diagram and Figure 12 for proper probe identification.



**FIGURE 23**

Ref. No.	Wiring Diagram Ref.	Part No.	Description
1	K1, (K2)	02530 02531 02539 02540	Contactator 50A Res. 120V AC Coil Contactator 50A Res. 240V AC Coil Contactator 75A Res. 120V AC Coil Contactator 75A Res. 240V AC Coil
2	HR1, (HR2)	02685 04164 04277 02686 04165 04253 04153 04166 04666 02281	Element 9kW, 208V, 3Ph Element 10kW, 208V, 3Ph Element 15kW, 208V, 3Ph Element 9kW, 240V, 3Ph Element 10kW, 240V, 3Ph Element 15kW, 240V, 3Ph Element 9kW, 480V, 3Ph Element 10kW, 480V, 3Ph Element 15kW, 480V, 3Ph Gasket Element
3	F1	02655 02125 02140	Fuse 5A, 250V Fuse 15A, 250V Fuse Block 30A, 250V 1Pole
Not shown	F2	03431 01520	Fuse Miniature 5A, 250V Fuse Block Miniature 250V 1Pole
4	B1	04178 03774	Pump with Cord 120V AC Pump 240V AC
5	SOL1	04761 02584	Solenoid Valve 3/8" NPT 120V AC/DIN-Connector Solenoid Valve 3/8" NPT 240V AC
6	A1/A2	20838	Boiler Controller 04316-EBC-LED-STM(1)
7	S3	04163 04162	Pressure Control Operating 100psi Pressure Control Operating 15psi
8	S4	04296 04162	Pressure Control High Limit 100psi Pressure Control High Limit 15psi
9		02396	Water Gauge Set
10		04569	Gauge Glass 5/8" OD x 4.125"
11		02006	Gauge Rubber Washer
12		02490	Valve Ball 1/2" NPT
13		03346	Valve Ball 1/2" NPT w/Latch
14		02370	Valve Check Ball Cone 1/2" NPT
15		02011 02011	Valve Globe 3/8" NPT Valve Globe
16		02637 02010	Valve Safety 1/2" NPT Valve Safety 3/4" NPT
17		04661 02451	Pressure Gauge 2.0" 1/4" NPT, 0-160psi Pressure Gauge 2.5" 1/4" NPT, 0-30psi